

Figure 1

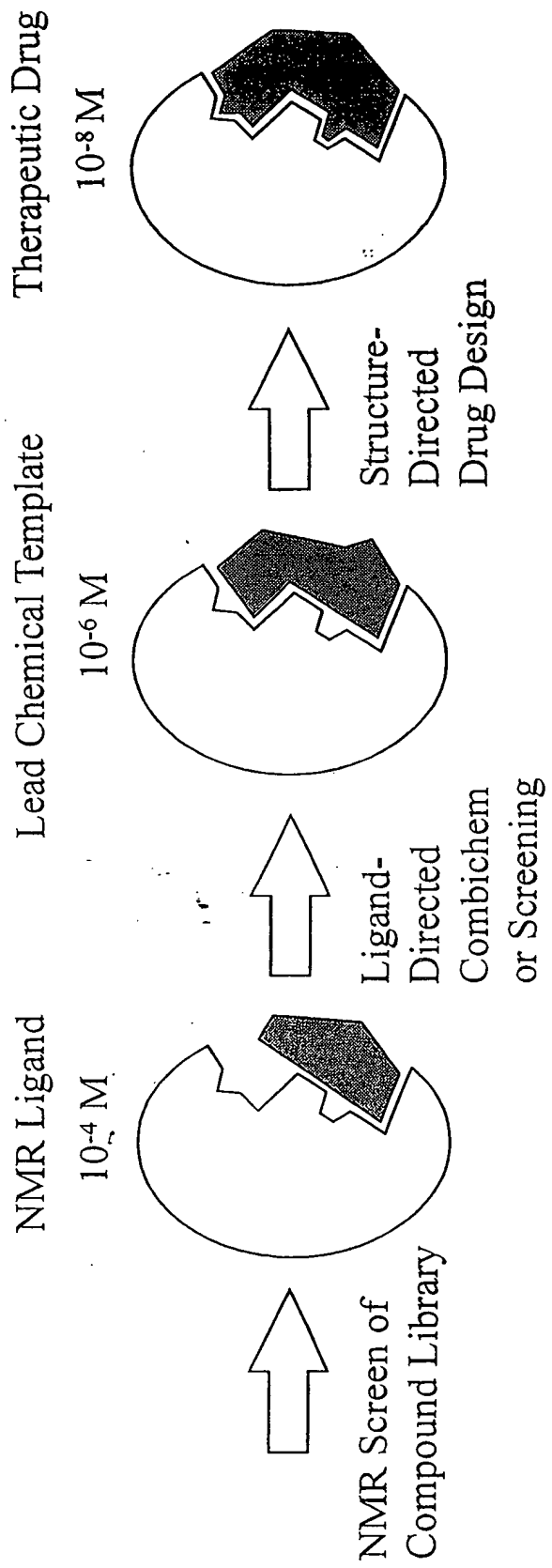
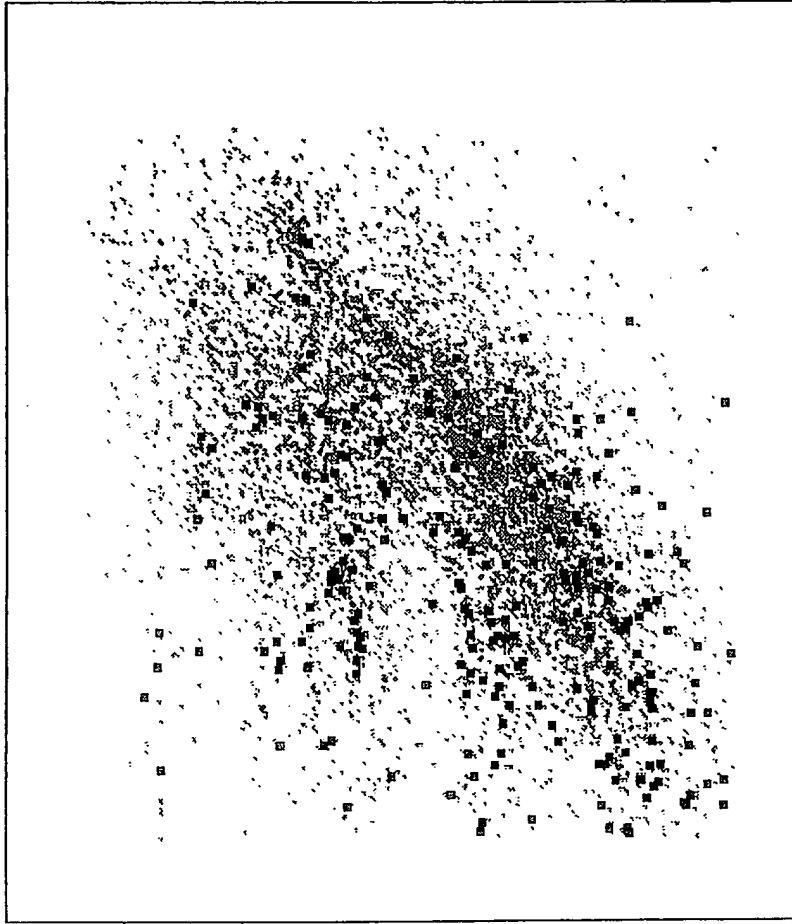

Figure 2



HA BCUT

CHRG BCUT

Figure 3

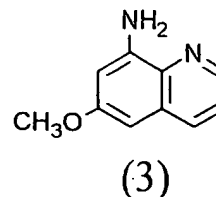
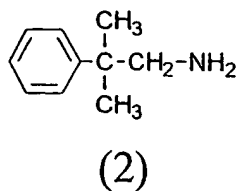
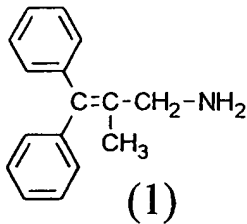

A

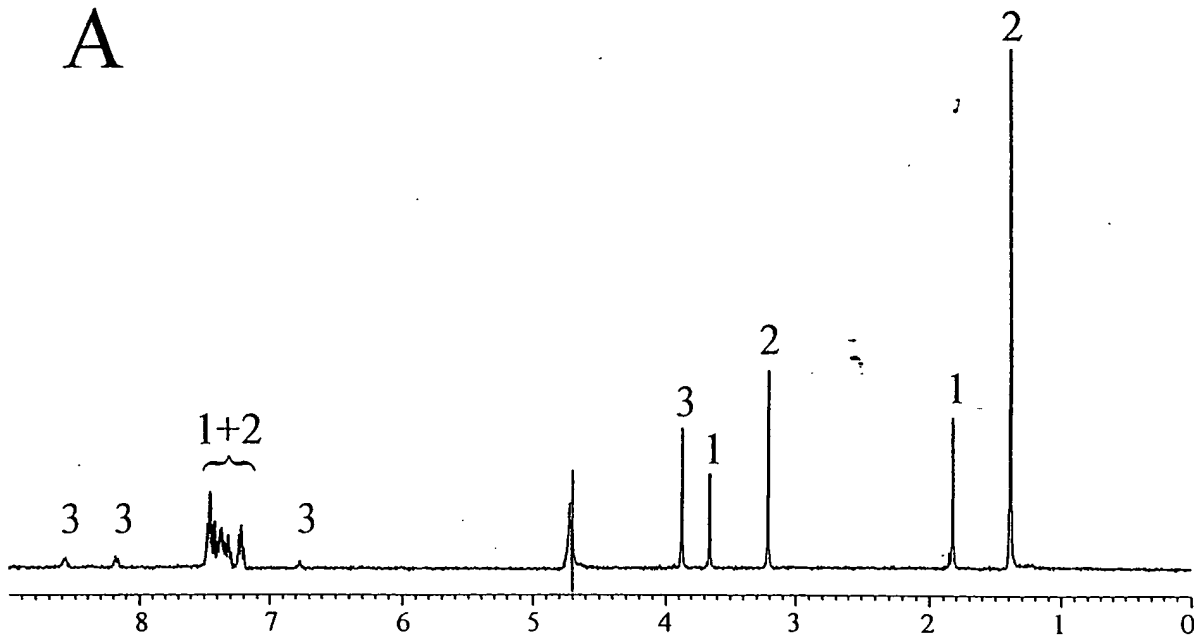

B

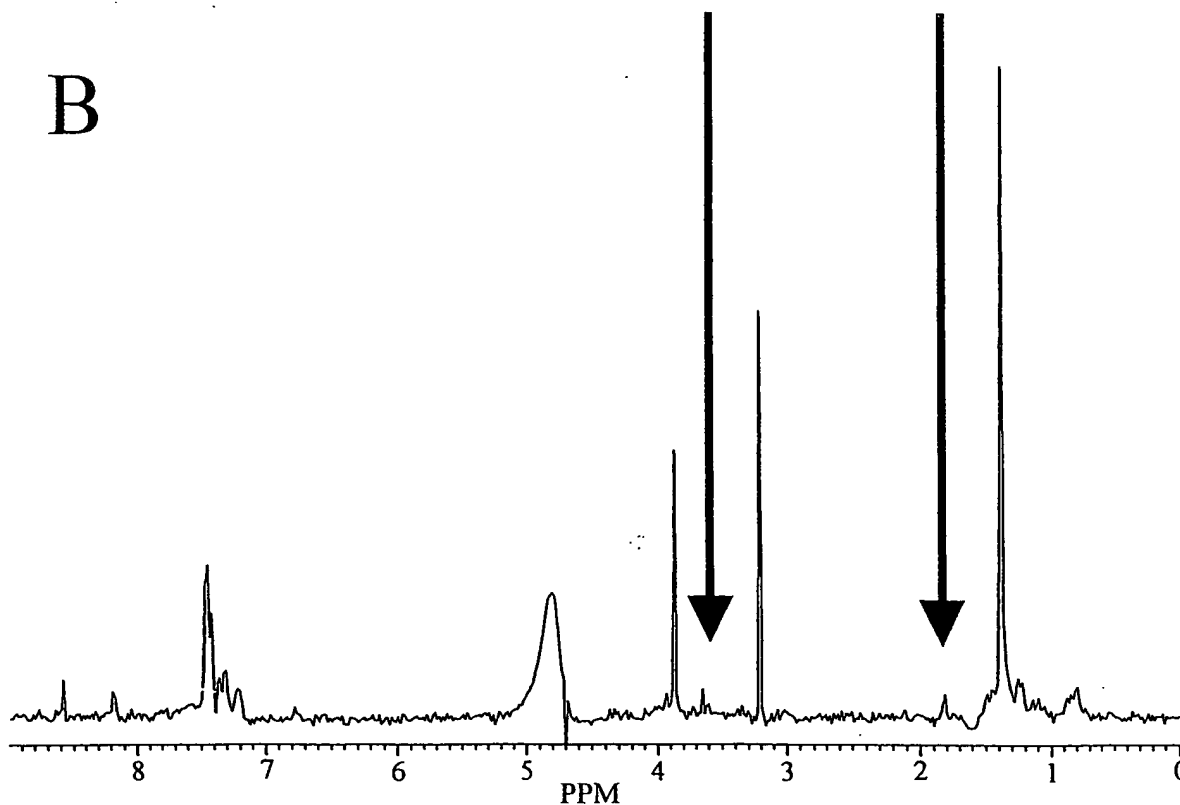

FOR OFFICIAL USE ONLY

Figure 4

A

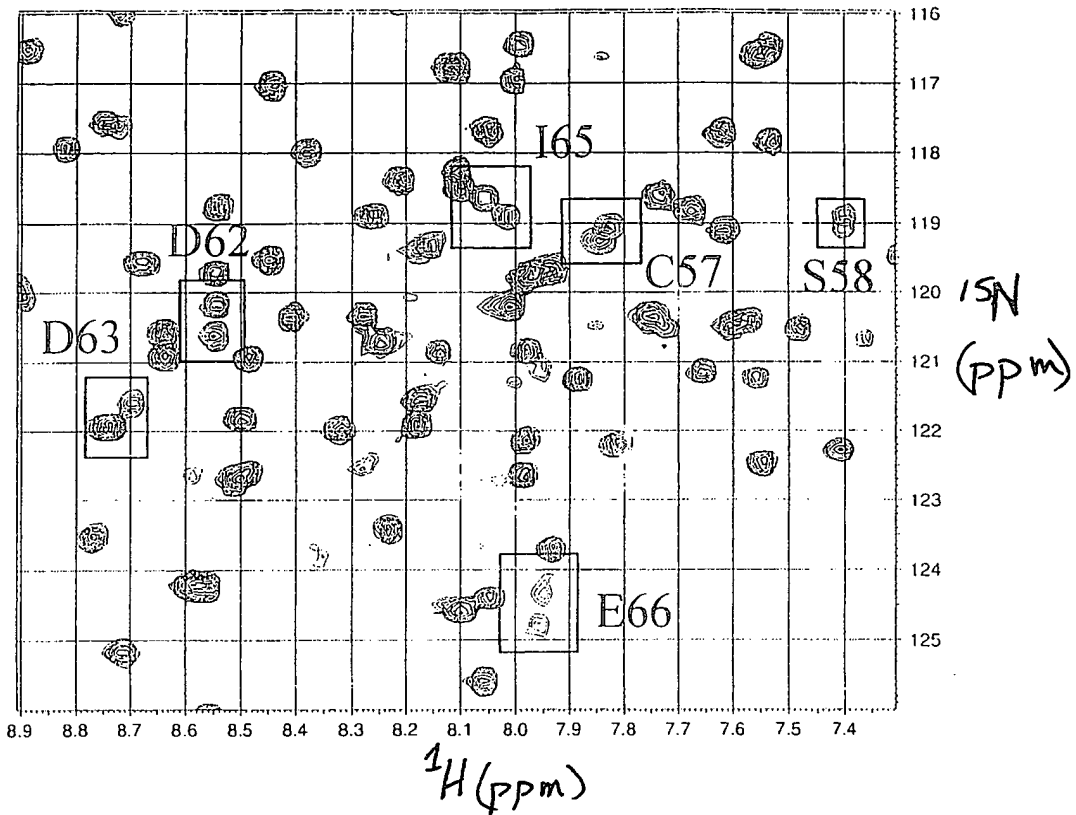

FOOTPRINT SHOOT

B

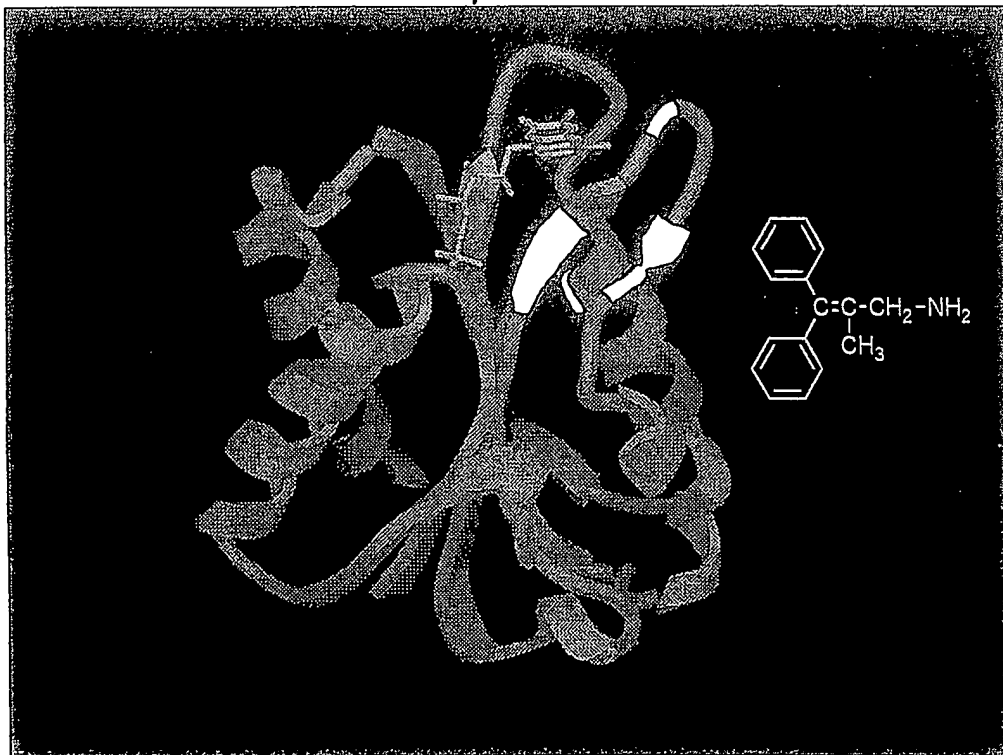

A *Figure 5*

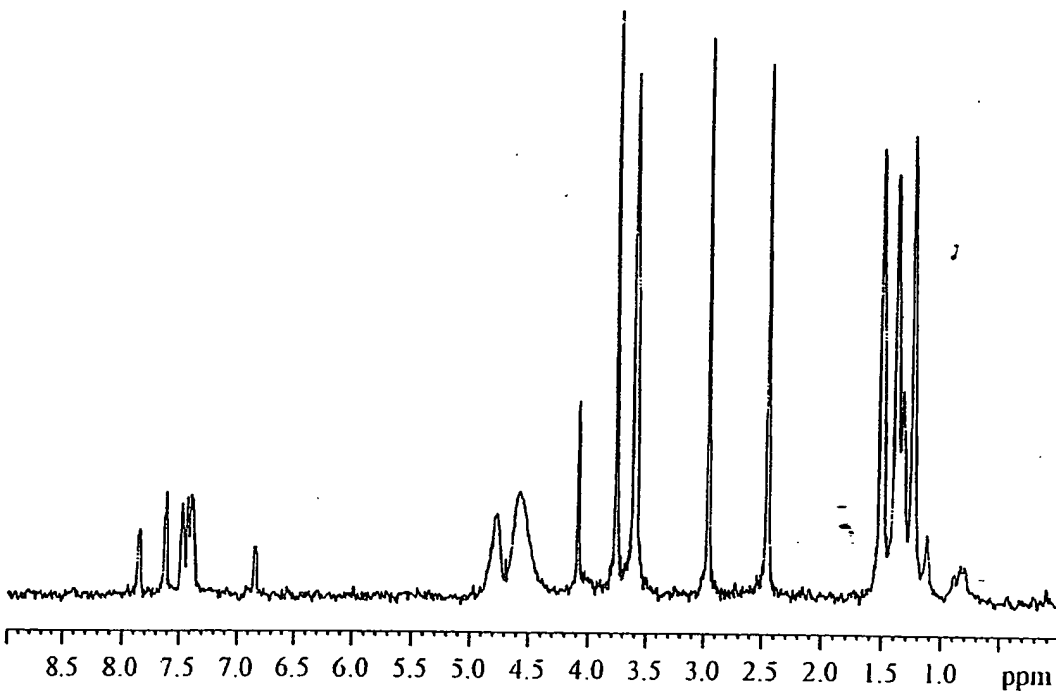

B

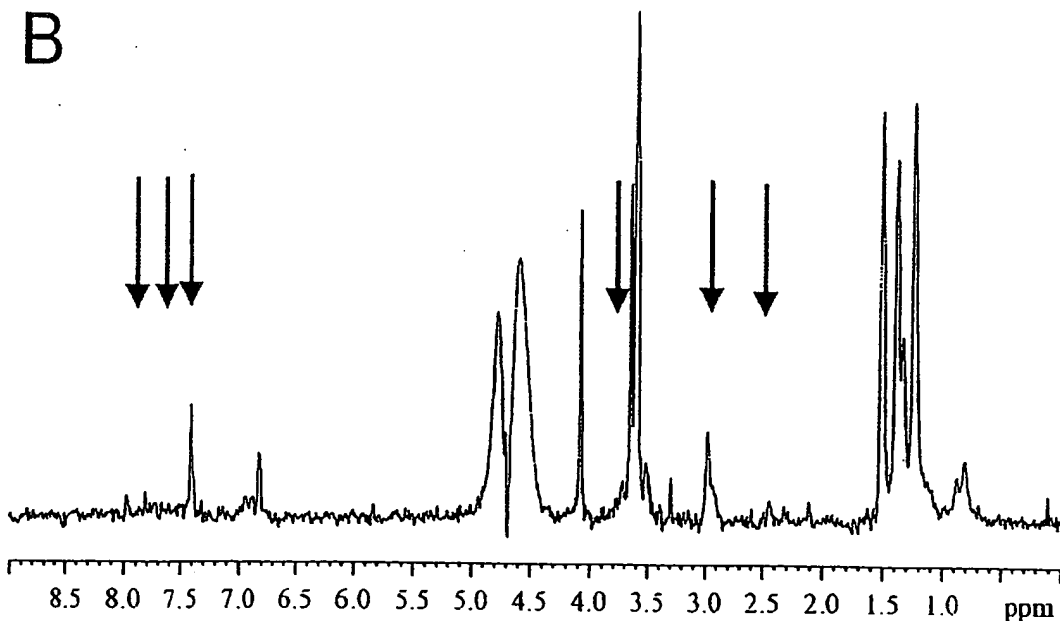

FOOTPRINT

FIGURE 6

Figure 6

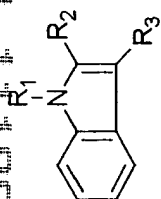

Ligand A  $IC_{50} \sim 9.0 \times 10^{-5} M$

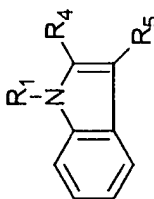

Ligand B  $IC_{50} = 1.8 \times 10^{-5} M$

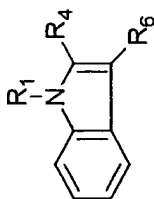

Ligand C  $IC_{50} = 1.8 \times 10^{-5} M$

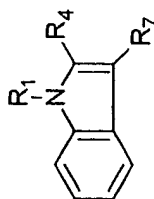

Ligand D  $IC_{50} = 1.2 \times 10^{-5} M$

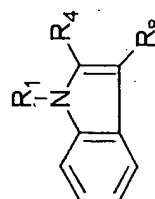

Ligand E  $IC_{50} = 3.2 \times 10^{-6} M$

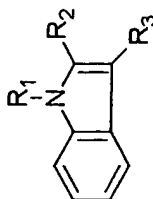

Ligand A  $NMR K_d \sim 1.4 \times 10^{-4} M$

FIGURE 7  
SPECTROSCOPY

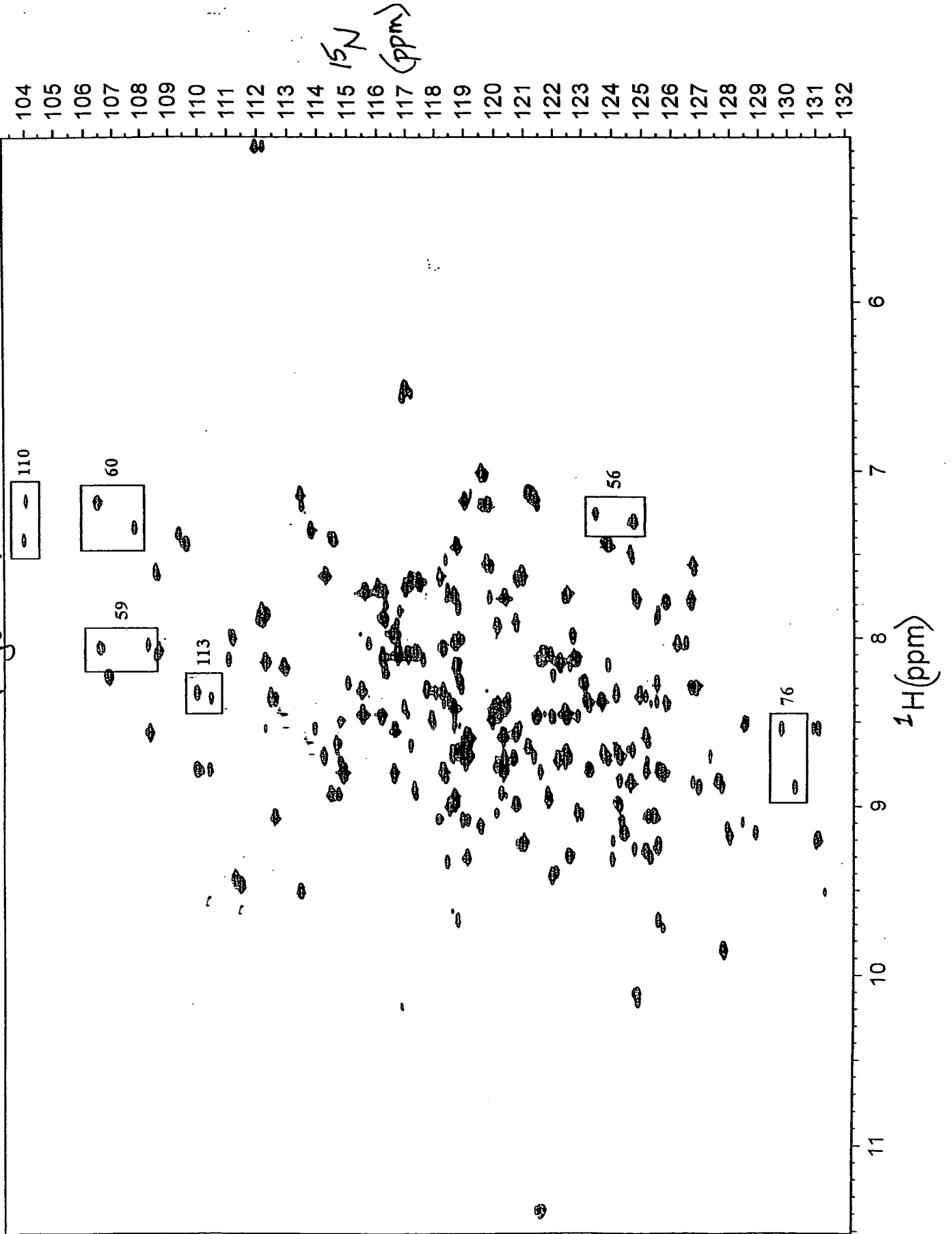

FOOTNOTES  
Figure 8

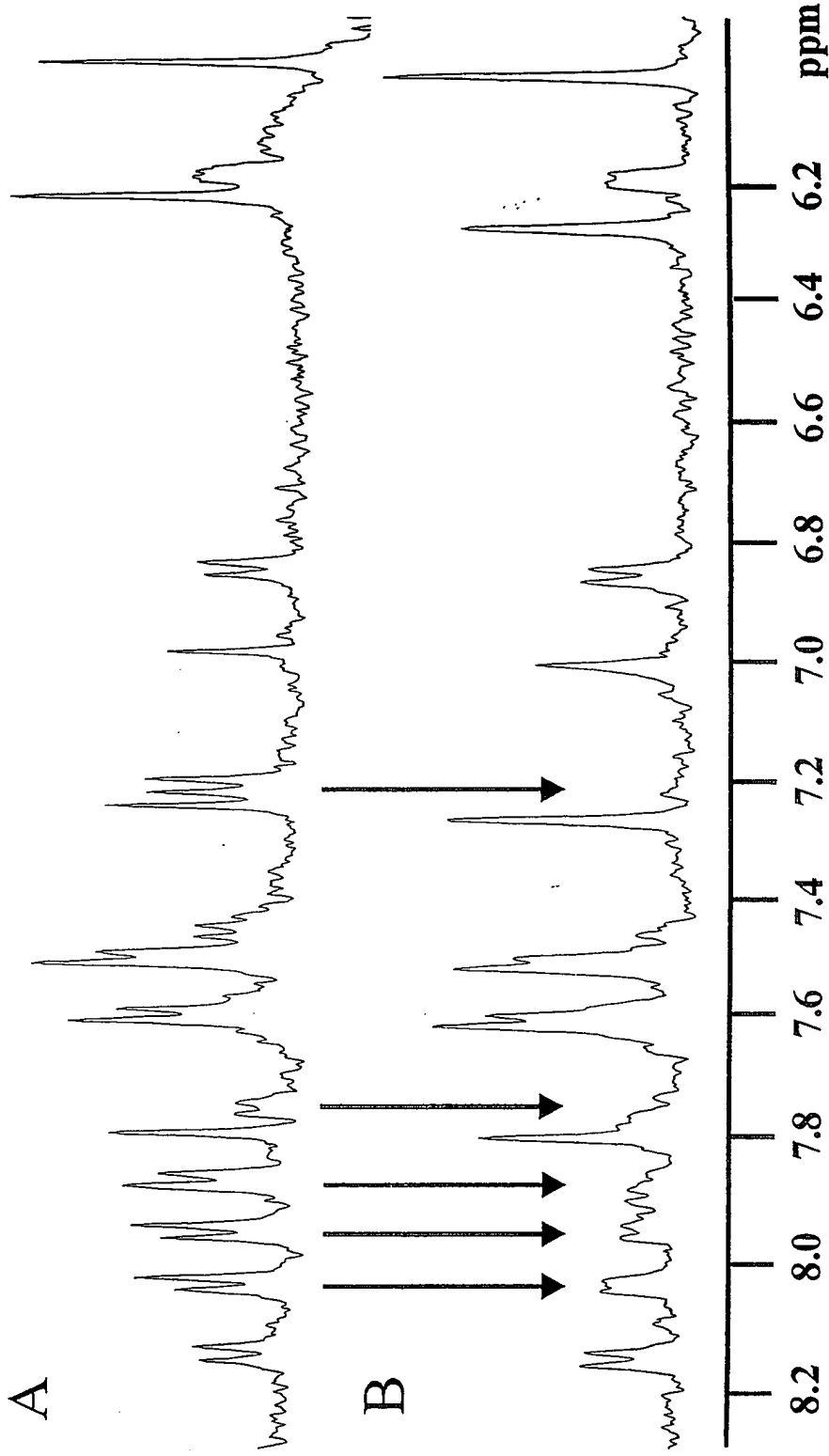



Figure 9

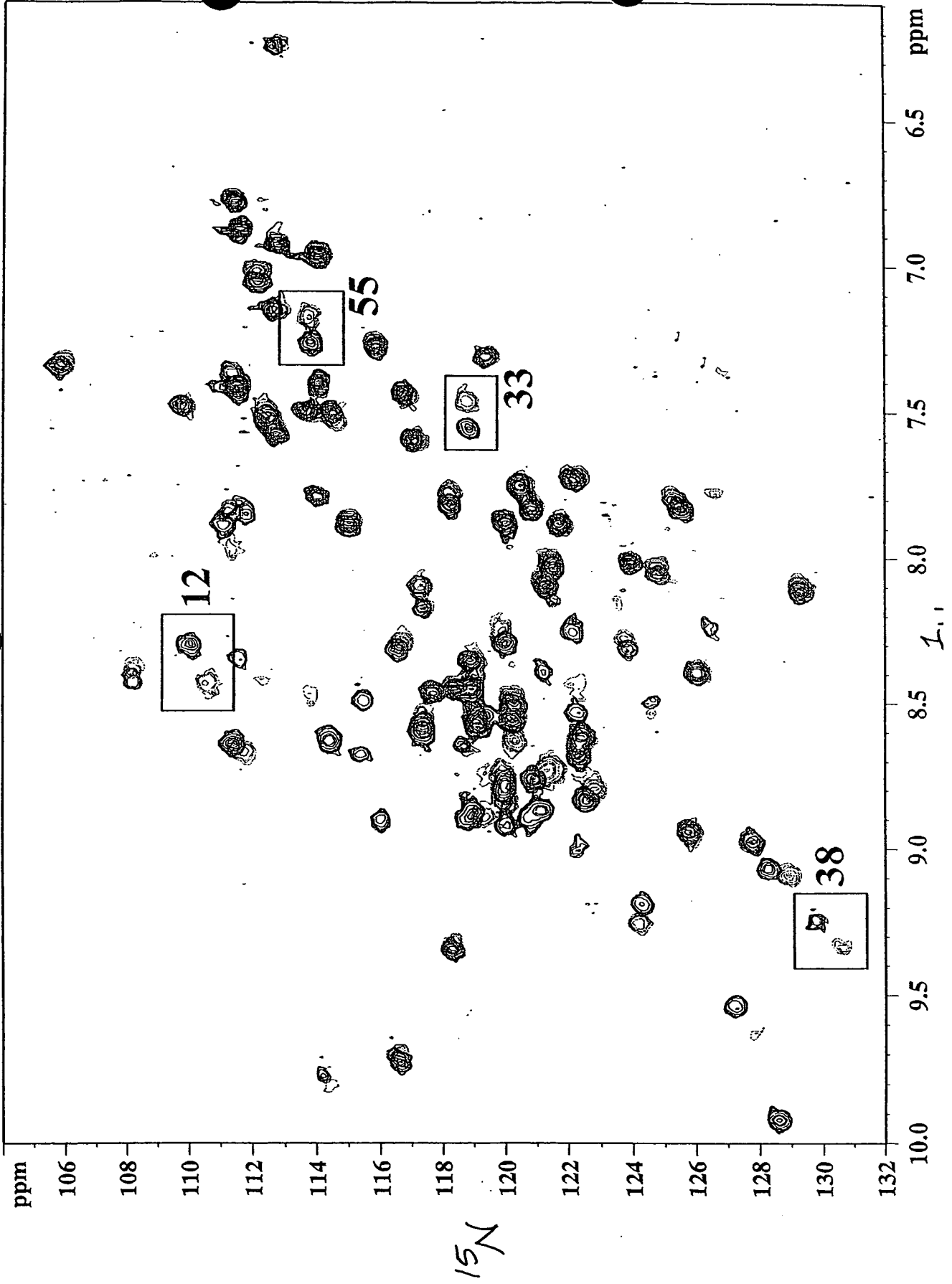
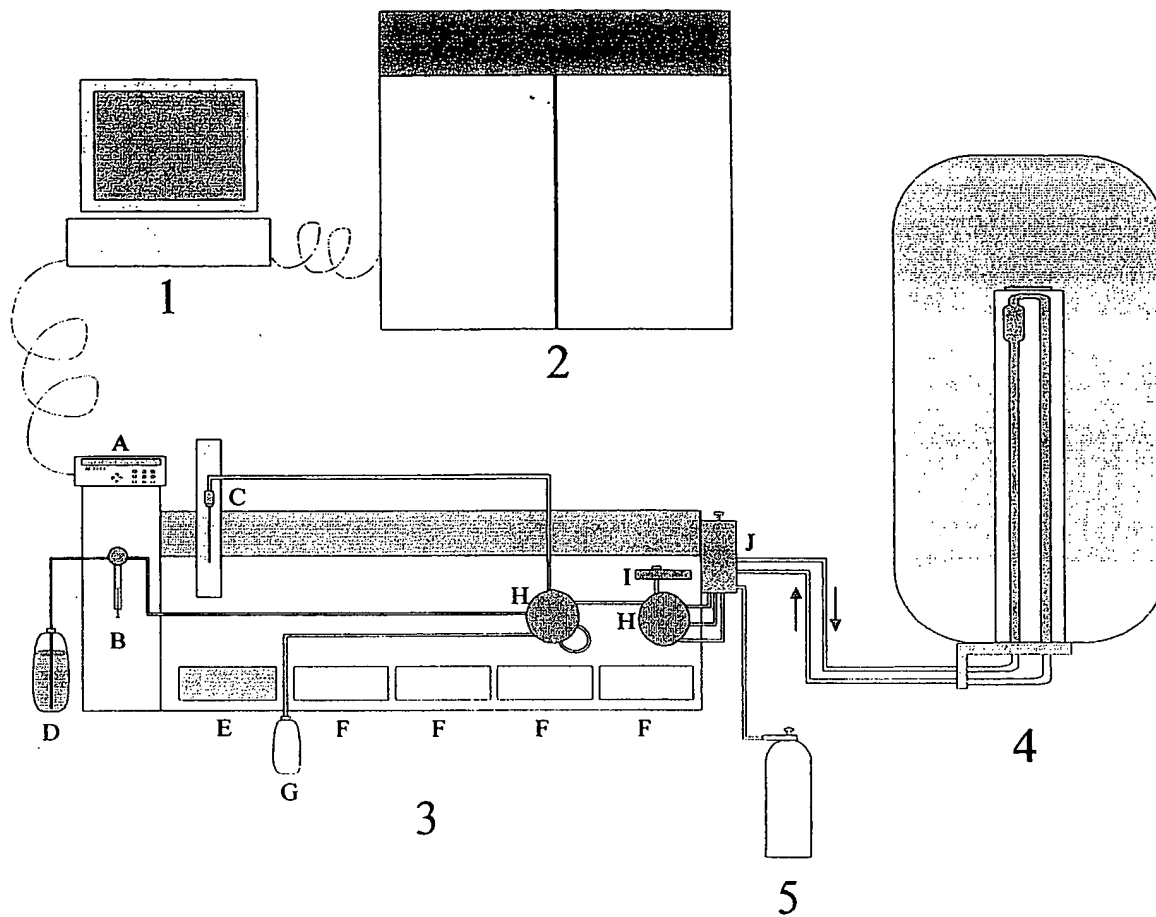

Figure 10.



FOOTPRINT

Figure 11.

FIGURE 11

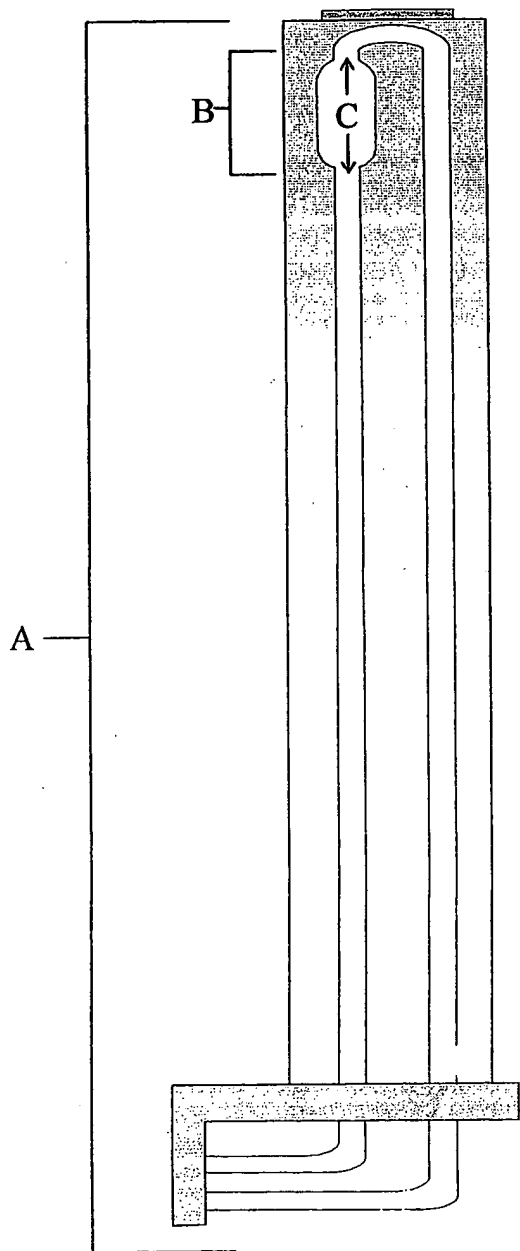

Figure 12.

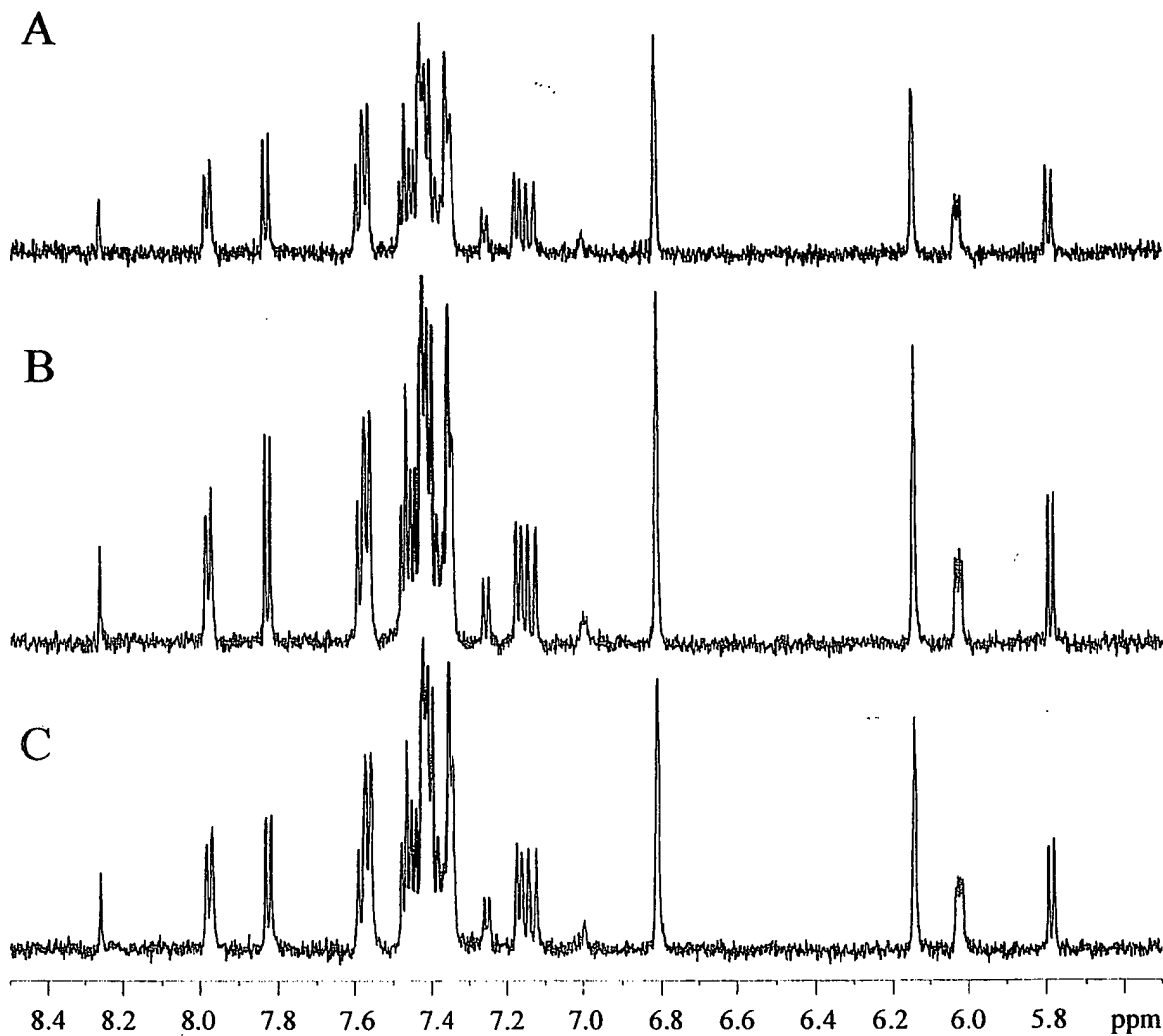
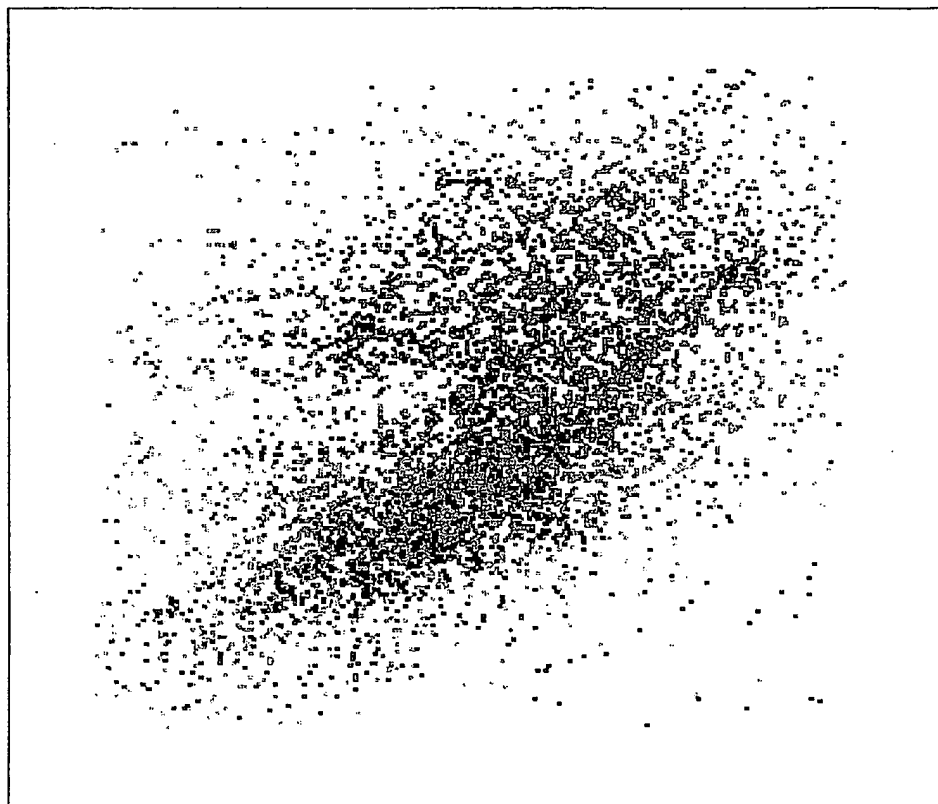

Figure 13.

FO6FFF"6F2H00F

HA BCUT



CHRG BCUT

Figure 14.

FOOTNOTES

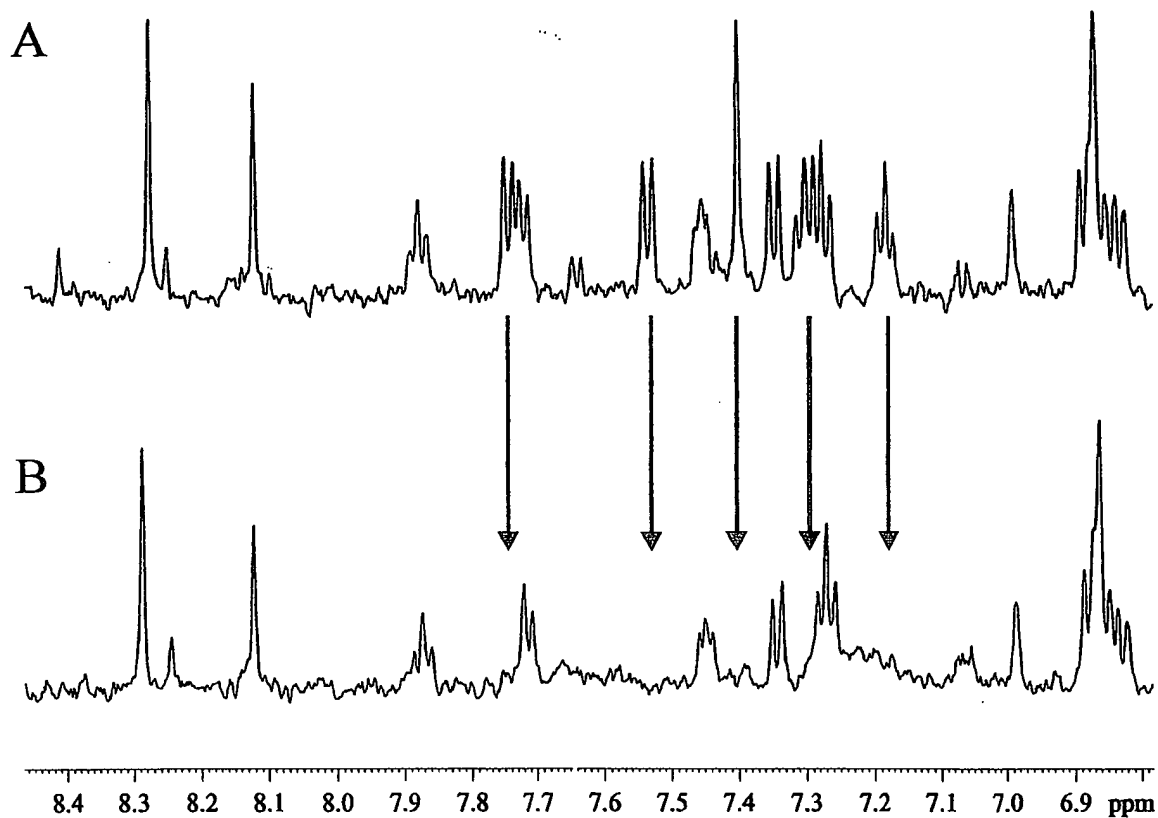
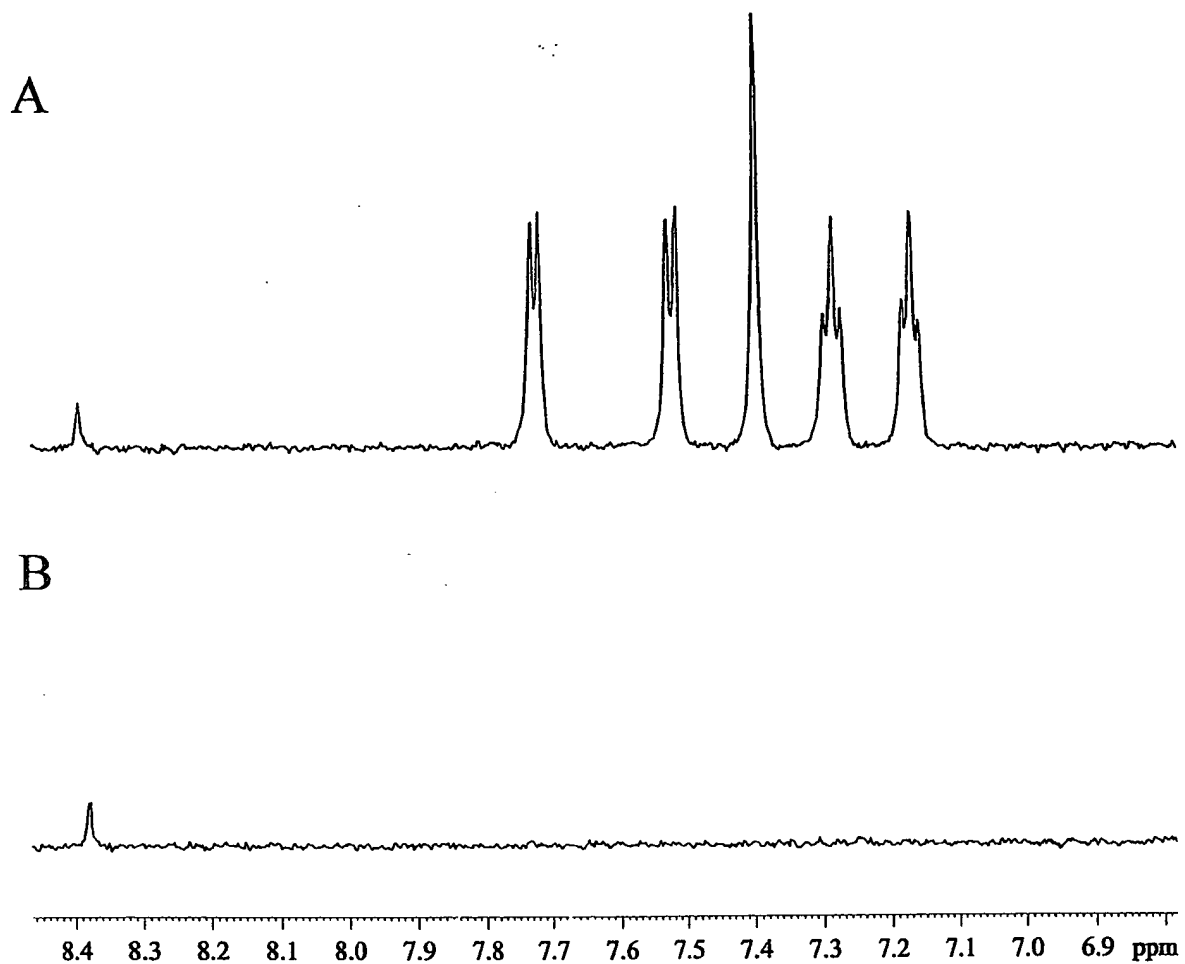

Figure 15



FOOTPRINT

Figure 16

FOURTH SHEET

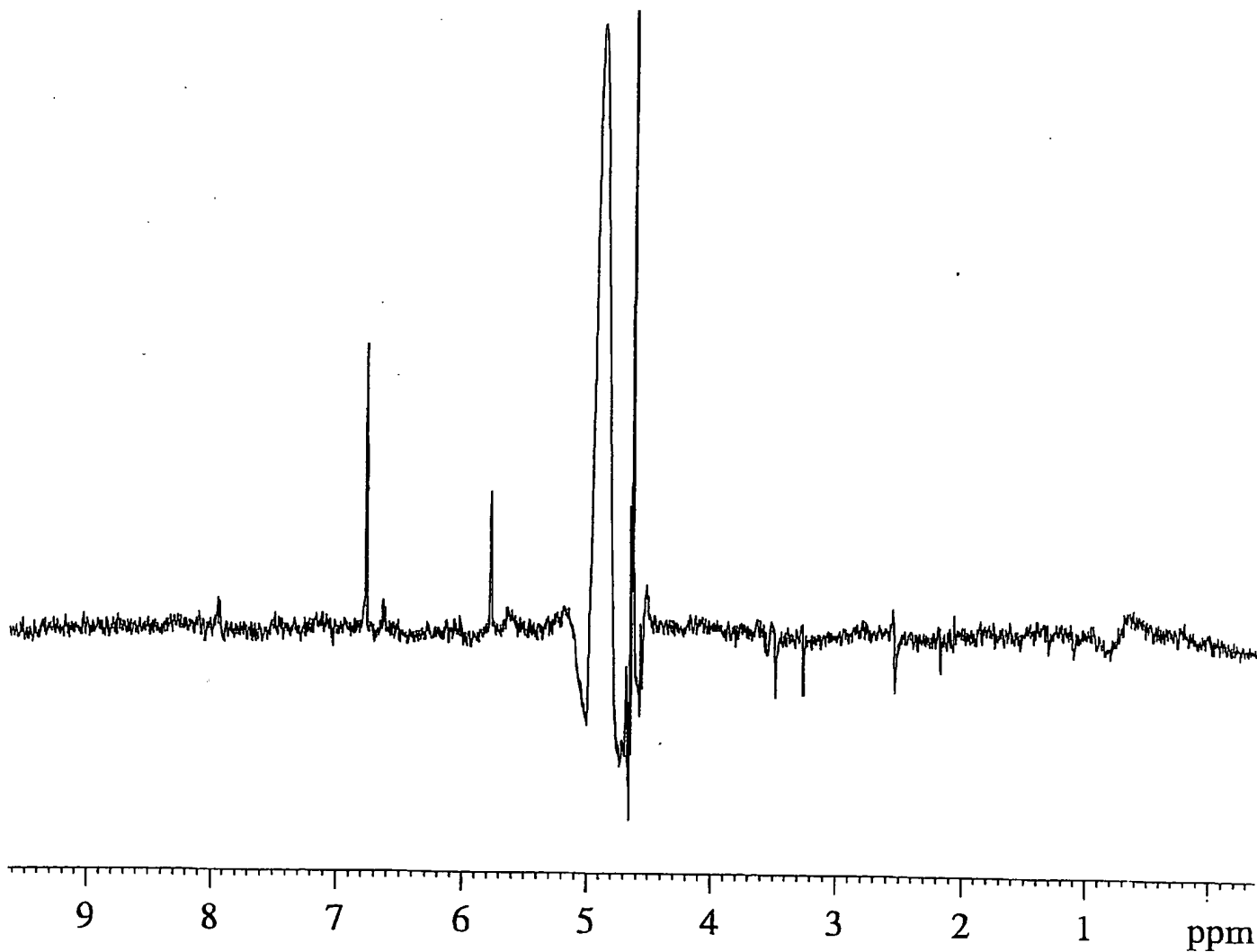



### DPS binding to Thrombin

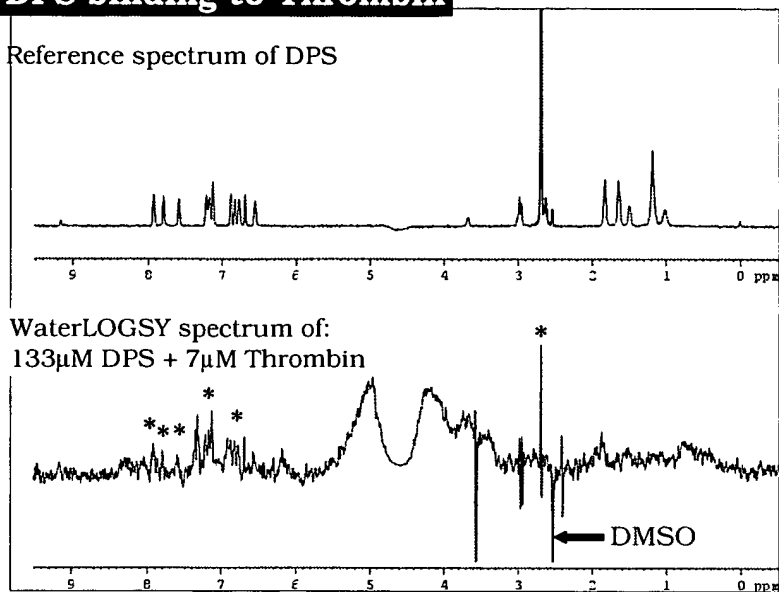

Figure 17

FOOTNOTES